



OZOBOT

Ozobot Labyrinth II



Übung



individuell



8 Jahre+



Vorwissen:
Keines



Der Ozobot folgt Linien. Um dies zu testen und um zu sehen, wie der Ozobot funktioniert, kannst Du die Übung Ozobot Labyrinth II verwenden. Neben schwarzen Linien folgt der Ozobot auch anderen Farben. Er kennt viele verschiedene Codes. Baue dein eigenes Labyrinth und lass den Ozobot die einzelnen Bauteile finden, die du für den Bau deines Roboters benötigst.



Lernkompetenzen

- > Verständnis über Sensorik und Farbcode Programmierung
- > Problemlösekompetenzen mit Hilfe von Robotik und Farbcodes

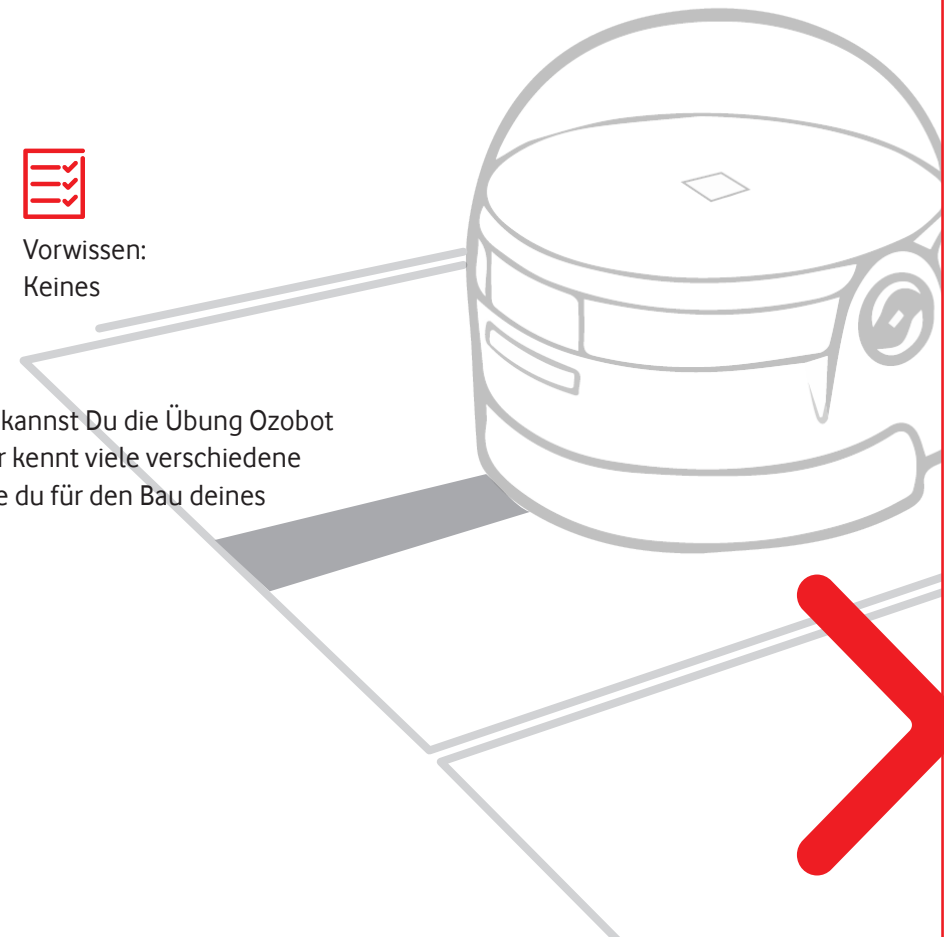

Vorbereitungen für deine Ozobot Labyrinth II

Benötigte Materialien

- > Ozobot
- > Rote, blaue und grüne Marker
- > Rote, blaue und grüne Klebepunkte
(Alternative für die Marker)

Zum Bau des Spielfeldes benötigst du:

- > Schere,
- > Kleber
- > dickeren Karton als Unterlage
oder 300 gr Papier für den Ausdruck

Schritt 01:

Drucke die folgenden Seiten und schneide die einzelnen Felder aus. Die Bilder in den grauen Kästchen sind die Ziele/Bauteile, die der Ozobot für den Bau deines Roboters suchen muss. Besprich mit den Kindern vor der Spielphase die Abbildungen, um ihre Bedeutung zu klären.

Schritt 02:

Lege die Labyrinthkarten aus und baue einen Parcours, durch den die anderen Kinder und du den Ozobot steuern müssen. Sammle die einzelnen Bauteile ein, indem ihr den Ozobot auf die jeweilige Karte fahren lasst.

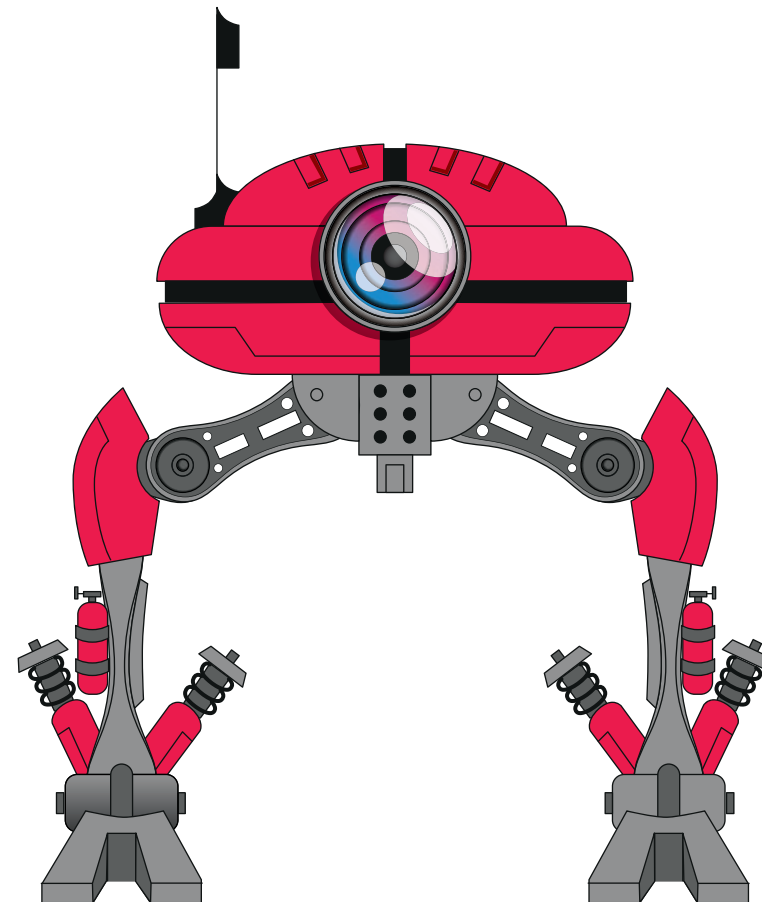

CFT-2020 RB-12

Vorlage Tüftlerblatt

Wozu gehören die einzelnen Abbildungen?
 Ordne die folgenden Begriffe zu.

1) Programm, 2) Strom, 3) Sensor, 4) Hardware

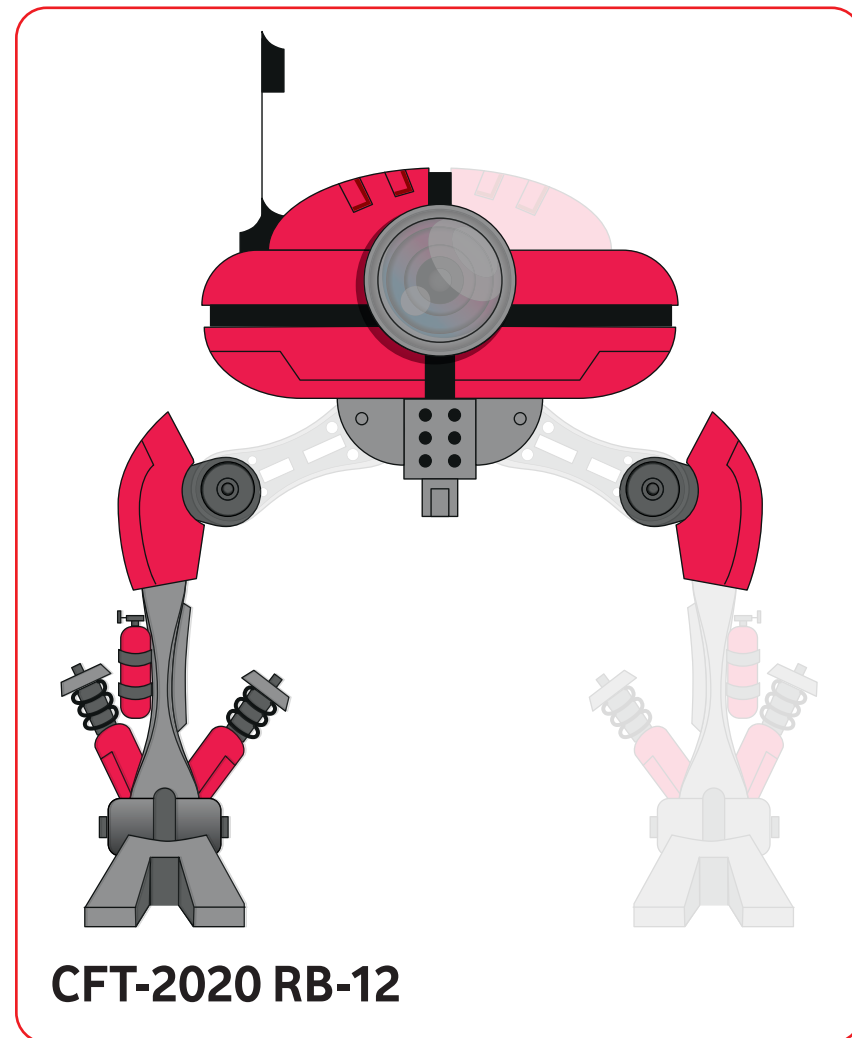
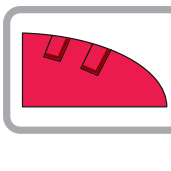
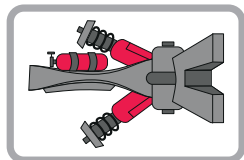
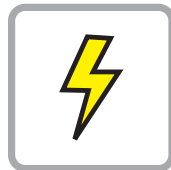

CFT-2020 RB-12

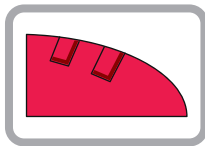
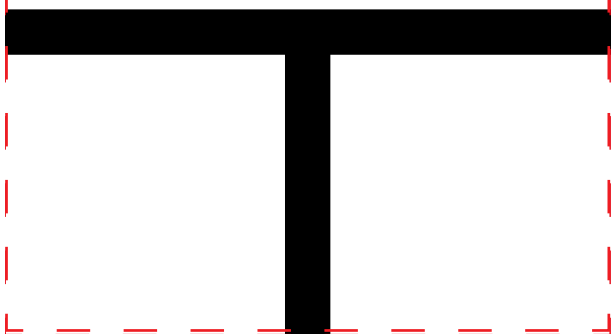
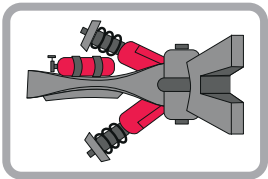
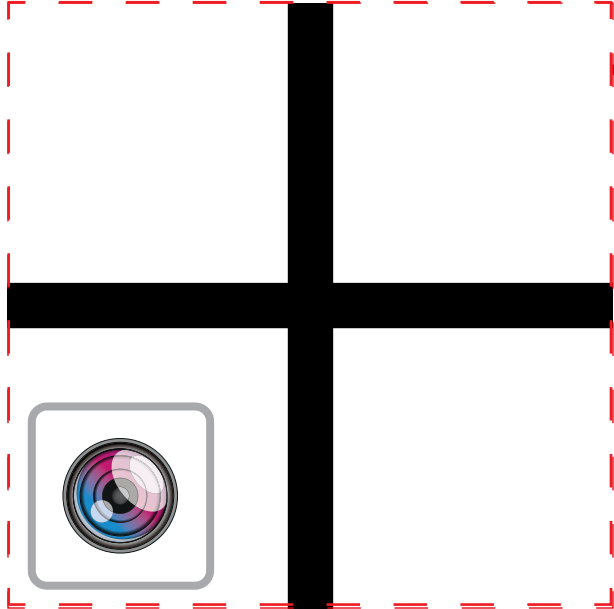
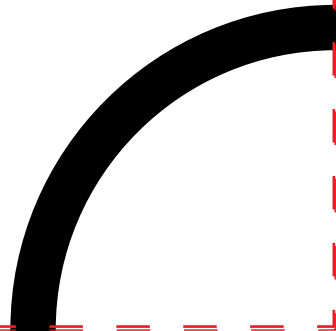

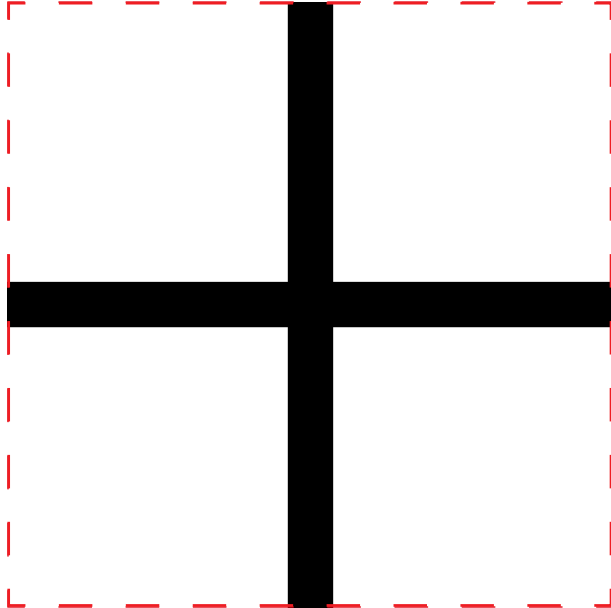
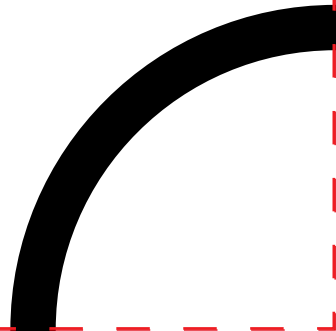

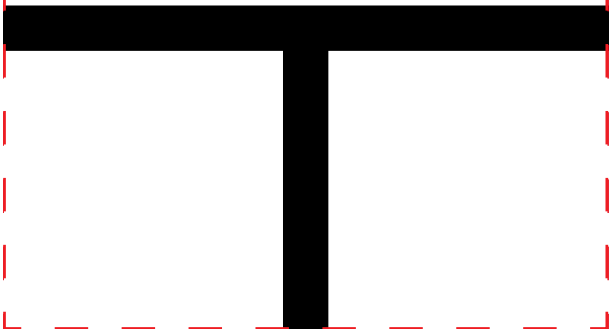
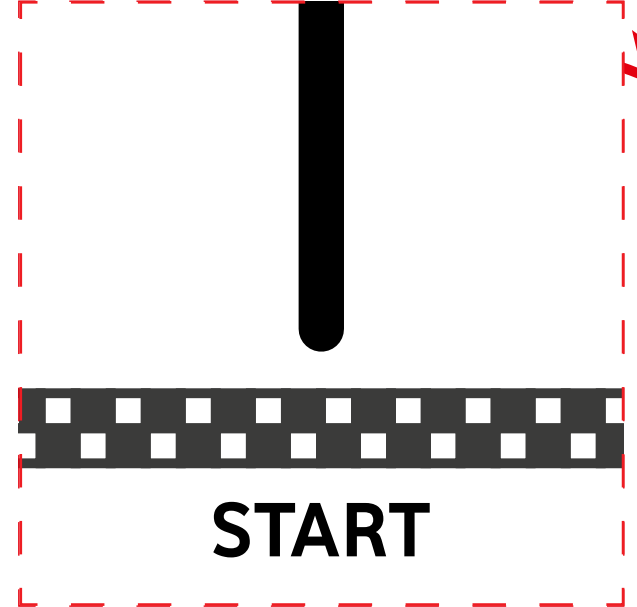
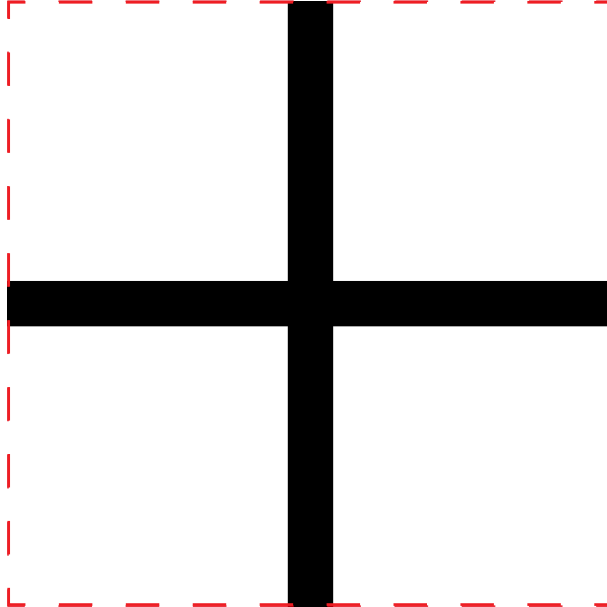
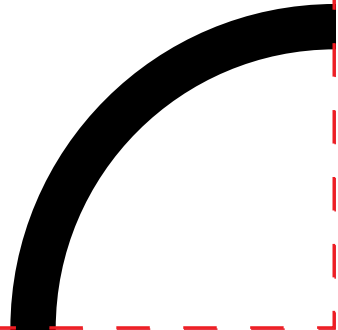

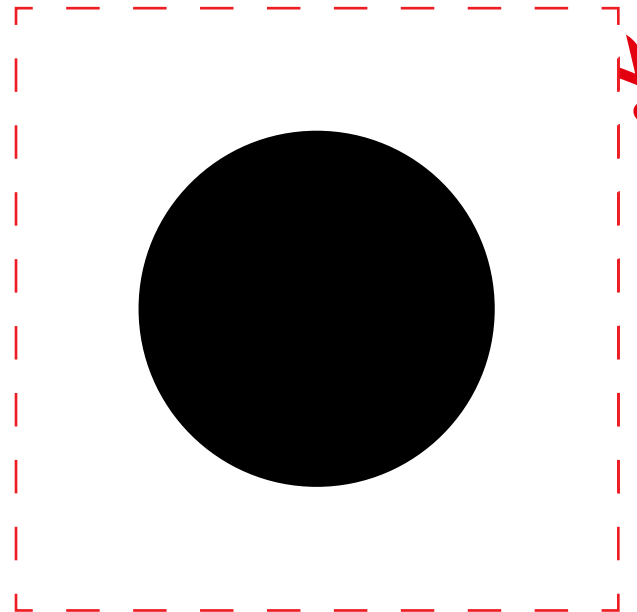
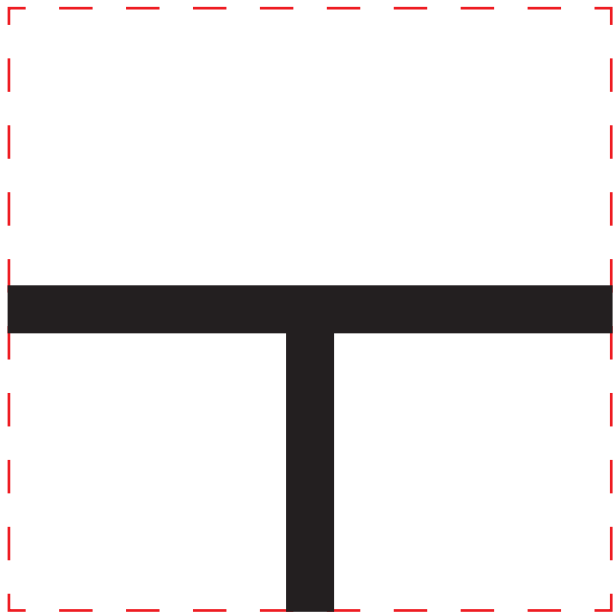
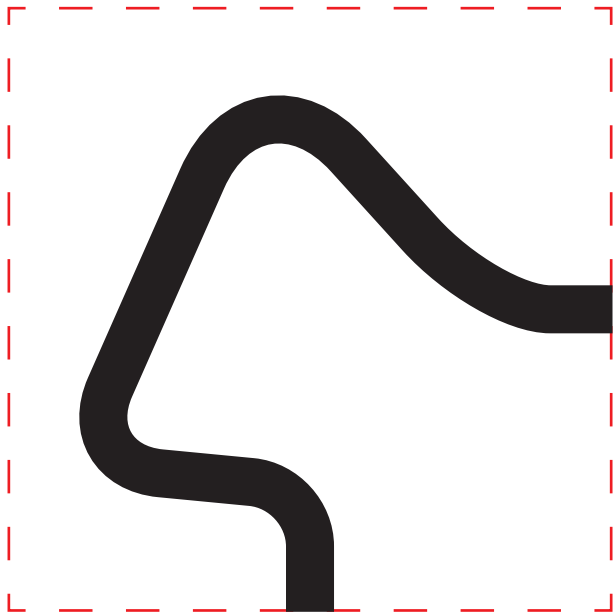
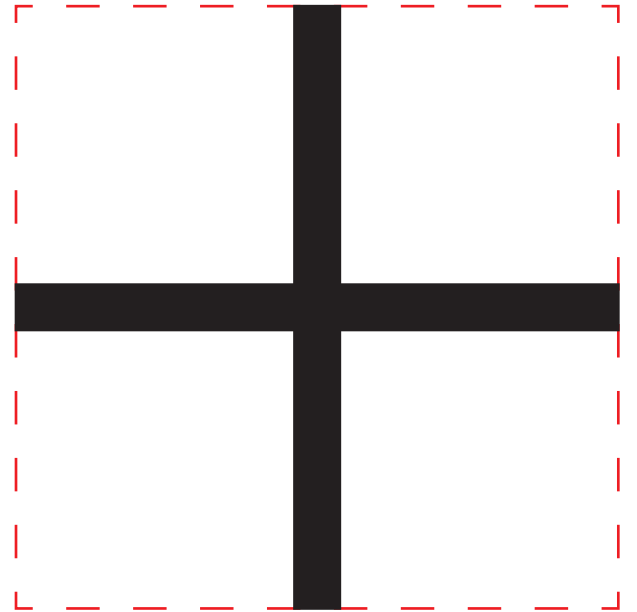
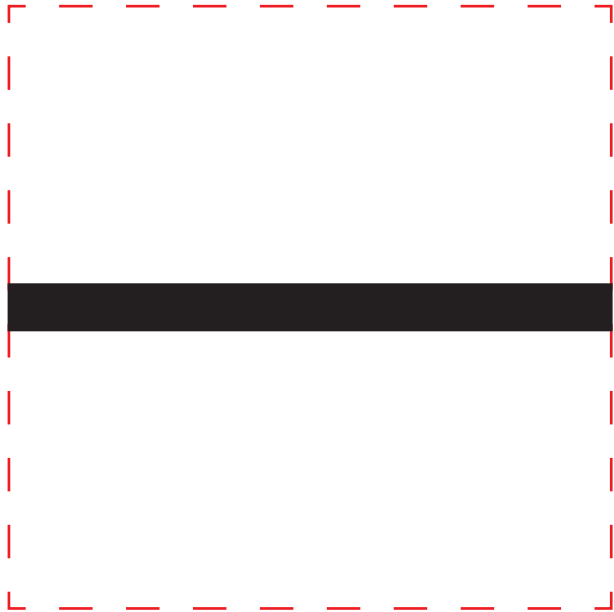
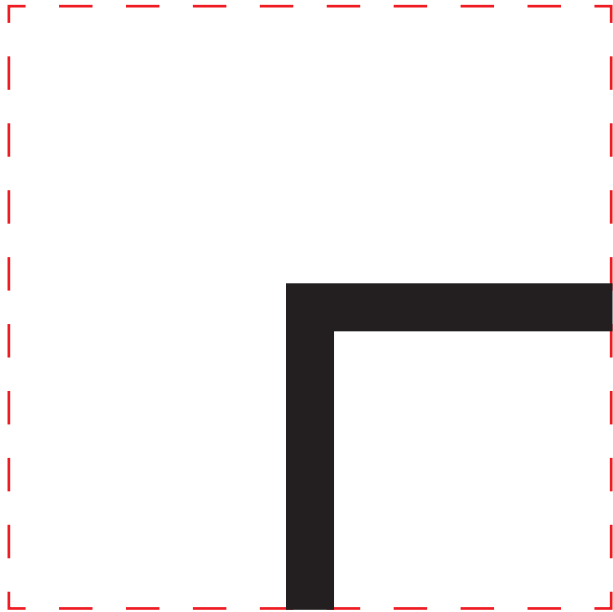

NITRO SCHUB →



LINKS ABbiegen →



← VERLANGSAMUNG



GERADEAUS FAHREN →



RECHTS ABbiegen →

